

# DV60

## Dual View Trucks



**WACKER  
NEUSON**  
*all it takes!*



### Safe like a truck, compact like a dumper

The driver's cab concept allows the operator to turn the seat and console 180 degrees to determine the viewing and driving direction. The rotation can be conveniently performed from the driver's seat by simple unlocking the seat console and then turn it around.

- High driving and working position
- Hydrostatic drive
- More ease of use thanks to the ergonomic rotary console
- Comfort cabin

## DV60 Technical specifications

	Front tip skip	Swivel tip skip
<b>Operating data</b>		
Payload kg	6,000	6,000
Shipping weight standard components kg	4,002	4,209
Shipping weight kg	4,002 - 4,327	4,209 - 4,534
Operating weight kg	4,148 - 4,473	4,355 - 4,680
Skip capacity - stroke l	2,700	2,350
Skip capacity - heaped l	3,600	3,150
Skip capacity - water measure l	1,900	1,600
<b>Engine / Motor</b>		
Engine / Motor manufacturer	DEUTZ	DEUTZ
Engine / Motor type	TD2.9 L4	TD2.9 L4
Engine / Motor	water-cooled 4-cylinder turbo-diesel	water-cooled 4-cylinder turbo-diesel
Engine performance kW	55.4	55.4
Displacement cm <sup>3</sup>	2,900	2,900
Engine RPM rpm	2200	2200
Emissions	level 3b / Tier IV final	level 3b / Tier IV final
Traction drive	4WD / hydrostatic	4WD / hydrostatic
Travel speed max. km/h	30	30
Articulation angle °	29	29
Pendulum angle °	11	11
Turning radius mm	6,100	5,980
Gradeability %	55	55
Tires	405/70-20	405/70-20
L x W x H mm	4,450 / 2,230 / 3,377	4,450 / 2,230 / 3,377
Steering pump	axial piston pump	axial piston pump
Flow rate l/min	123	123
Operating pressure bar	480	480
Duty pump	gear pump	gear pump
Flow rate l/min	70.2	70.2
Operating pressure bar	240	240
Tank capacity l	80	80
Sound level (LwA) dB(A)	101	101

## DV60 Dimensions

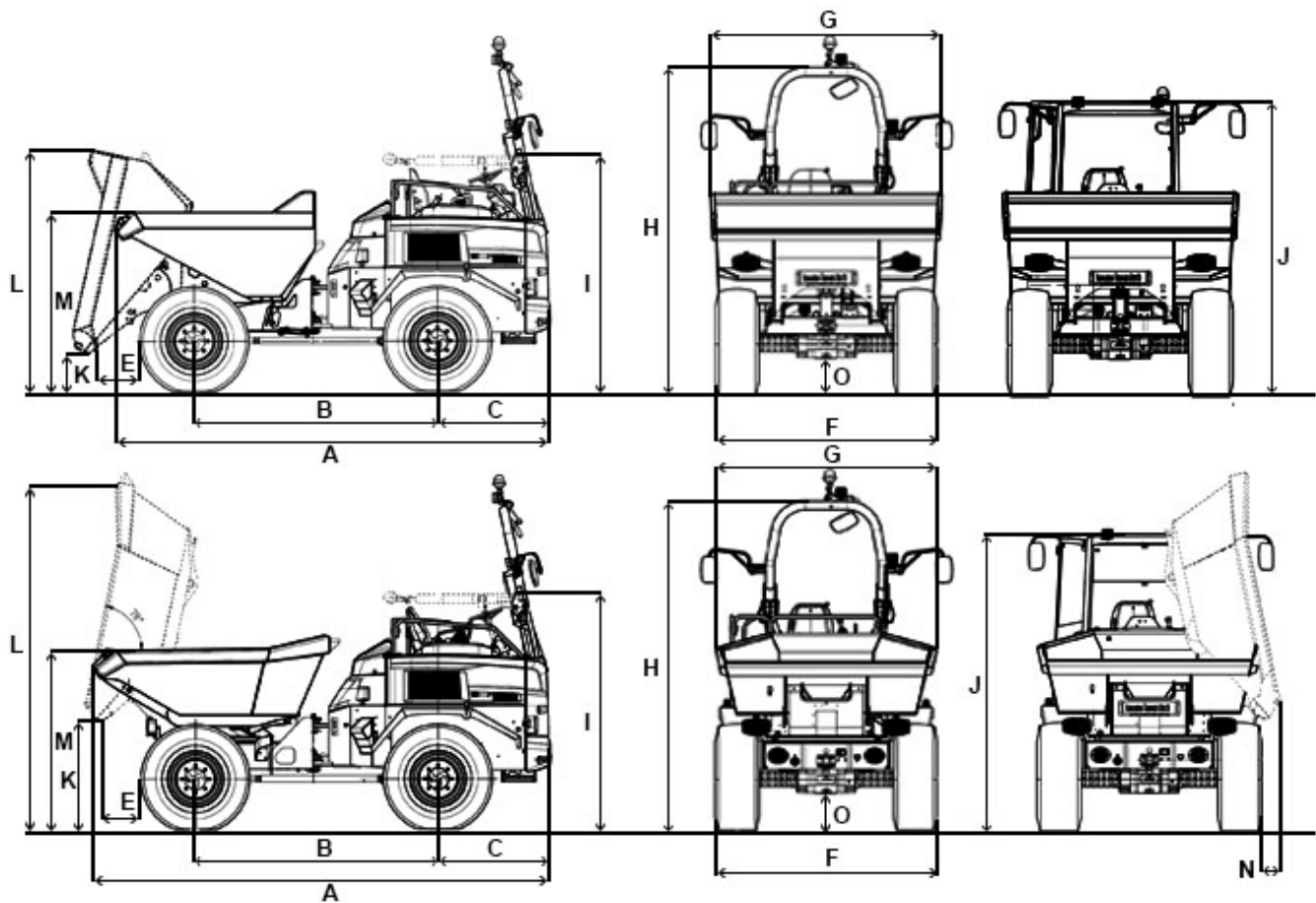

		Front tip skip	Swivel tip skip
A	Overall length ROPS	4,448 mm	4,699 mm
A	Overall length Cabin	4,448 mm	4,699 mm
B	Wheelbase	2,485 mm	2,485 mm
C	Rear overhang	1,157 mm	1,157 mm
E	Dumping distance	565 mm	456 mm
F	Width	2,230 mm	2,230 mm
G	Skip width	2,328 mm	2,218 mm
H	Height ROPS	3,377 mm	3,377 mm
I	Height ROPS tilted	2,400 mm	2,400 mm
J	Height Cabin	2,940 mm	2,940 mm
K	Dump height max.	385 mm	1,100 mm
L	Skip height tilted	2,463 mm	3,639 mm
M	Skip height	1,828 mm	1,981 mm
N	Dumping distance to the side		69 mm
O	Ground clearance	370 mm	370 mm
-	Dump angle	50 °	48 °

Please note: that product availability can vary from country to country. It is possible that information / products may not be available in your country. More detailed information on engine power can be found in the operator's manual; the stated power may vary due to specific operating conditions. Subject to alterations and errors excepted. Applicable also to illustrations.  
Copyright © 2020 Wacker Neuson SE.